

USB 2.0
Mini-B
Port

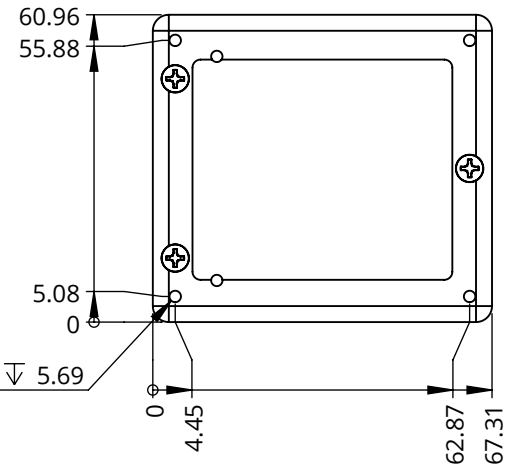

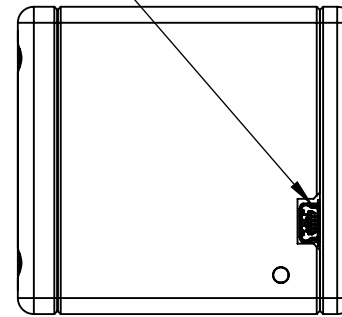
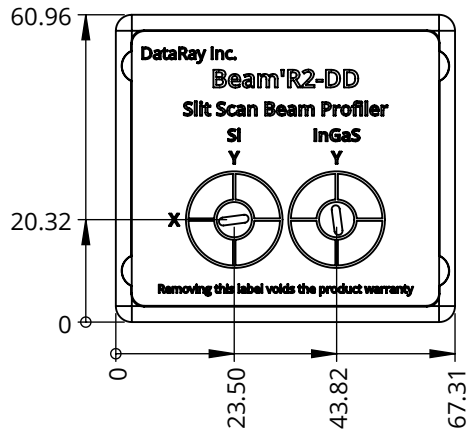
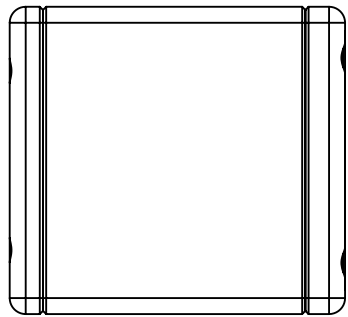

Units:
Millimeters

Beam'R2
Nominal plane distance from front of profiler case is 3.25mm. Profiler specific distance varies by unit.

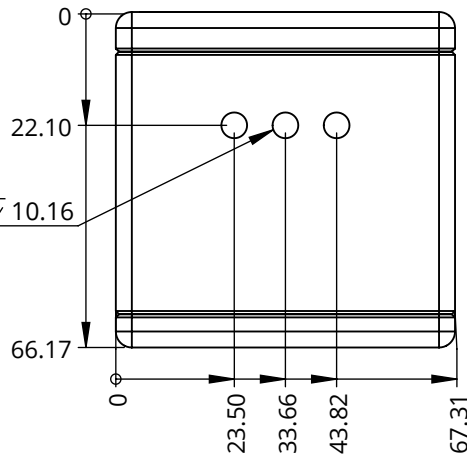
3 X 1/4"-20 MOUNTING HOLES ∇ 10.16



DATARAY.COM +1-866-946-2263 +1-530-776-0843			
THIRD ANGLE PROJECTION 		TITLE: <h2 style="text-align: center;">Beam'R2</h2>	
	NAME	DATE	
DRAWN	SM	20190605	
APPROVED	LJ	20190605	
SIZE		LTR	
REV	3	COPYRIGHT © 2018 BY DATARAY INC.	
SCALE:	1:1.5	SHEET 1 OF 1	